

NEU/NEW

KATALOG  
2024



**SCHWARZ** GmbH  
Vollhartmetall Präzisionswerkzeuge

- External Turning Holders Coolant
- Klemmhalter Gekühlt

### External Turning Holders With Coolant

#### 95° SCLCR IC

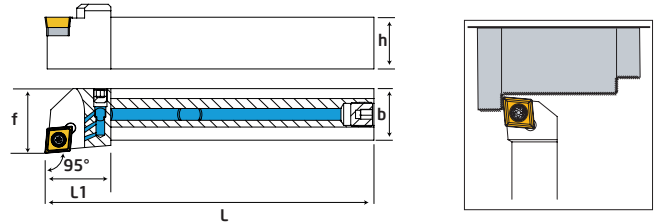
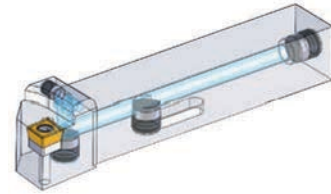

Product Code Produkt-Code	Dimensions(mm) Abmessungen (mm)						Insert WSP	Clamp Screw Torx- Schraube	Shim U-Platte	Shim Screw U-Platte Schraube	Torx Key Torx-Schlüssel
	L	L1	h	f	b	kg					
SCLCR 1616 H09- IK G1/8	100	25	16	20	16	0,205					
SCLCR 2020 K09- IK G1/8	125	25	20	25	20	0,418	CCMT 09T3	SW-SS-10	SW-UP-14	SW-GB-1	
SCLCR 2525 M12- IK G1/8	150	30	25	32	25	0,771	CCMT 1204	SW-SS-11	SW-UP-15	SW-GB-2	

### External Turning Holders With Coolant

#### 95° SCLCL IC

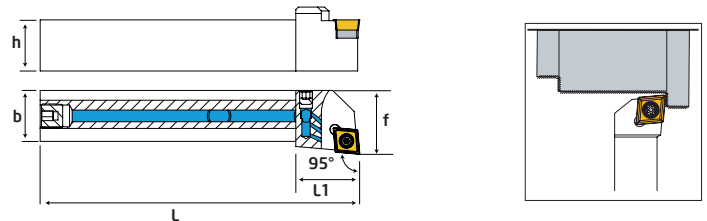
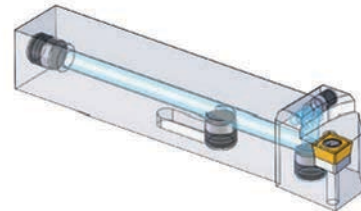

Product Code Produkt-Code	Dimensions(mm) Abmessungen (mm)						Insert WSP	Clamp Screw Torx- Schraube	Shim U-Platte	Shim Screw U-Platte Schraube	Torx Key Torx-Schlüssel
	L	L1	h	f	b	kg					
SCLCL 1616 H09- IK G1/8	100	25	16	20	16	0,205					
SCLCL 2020 K09- IK G1/8	125	25	20	25	20	0,418	CCMT 09T3	SW-SS-10	SW-UP-14	SW-GB-1	
SCLCL 2525 M12- IK G1/8	150	30	25	32	25	0,771	CCMT 1204	SW-SS-11	SW-UP-15	SW-GB-2	

### External Turning Holders With Coolant

#### 93° SDJCR IC

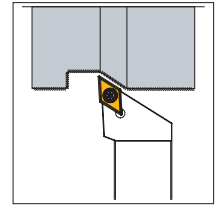
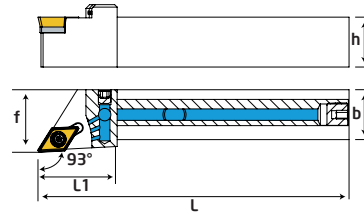
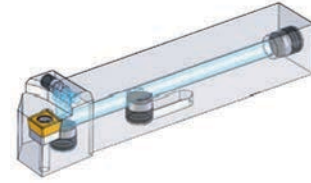

Product Code Produkt-Code	Dimensions(mm) Abmessungen (mm)							Insert WSP	Clamp Screw Torx- Schraube	Shim U-Platte	Shim Screw U-Platte Schraube	Torx Key Torx-Schlüssel
	L	L1	h	f	b	kg						
SDJCR 1616 H11- IK G1/8	100	32	16	20	16	0,204						
SDJCR 2020 K11- IK G1/8	125	32	20	25	20	0,404						
SDJCR 2525 M11- IK G1/8	150	35	25	32	25	0,735						

### External Turning Holders With Coolant

#### 93° SDJCL IC

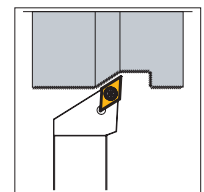
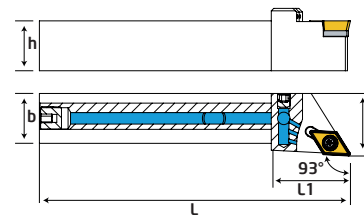
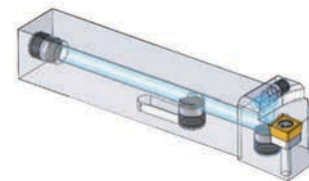

Product Code Produkt-Code	Dimensions(mm) Abmessungen (mm)							Insert WSP	Clamp Screw Torx- Schraube	Shim U-Platte	Shim Screw U-Platte Schraube	Torx Key Torx-Schlüssel
	L	L1	h	f	b	kg						
SDJCL 1616 H11- IK G1/8	100	32	16	20	16	0,204						
SDJCL 2020 K11- IK G1/8	125	32	20	25	20	0,404						
SDJCL 2525 M11- IK G1/8	150	35	25	32	25	0,735						

- External Turning Holders Coolant
- Klemmhalter Gekühlt

## External Turning Holders With Coolant

### 93° SVJCR IC

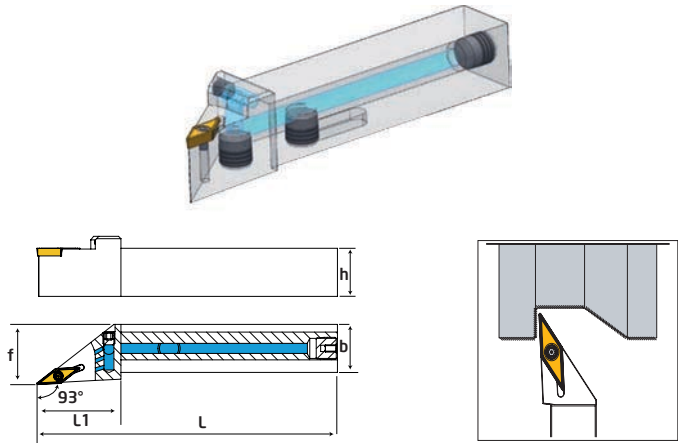

Product Code Produkt-Code	Dimensions(mm) Abmessungen (mm)						Insert WSP	Clamp Screw Torx- Schraube	Shim U-Platte	Shim Screw U-Platte Schraube	Torx Key Torx-Schlüs- sel
	L	L1	h	f	b	kg					
SVJCR 1616 H11- IK G1/8	100	25	16	20	16	0,204			---	---	
SVJCR 2020 K11- IK G1/8	125	33	20	25	20	0,378	VCMT 1103	SW-SS-12	---	---	T8
SVJCR 2020 K16- IK G1/8	125	33	20	25	20	0,385	VCMT 1604	SW-SS-10	SW-UP-22	SW-GB-1	T15
SVJCR 2525 M16- IK G1/8	150	40	25	32	25	0,683	VCMT 1604	SW-SS-10	SW-UP-22	SW-GB-1	T15

## External Turning Holders With Coolant

### 93° SVJCL IC

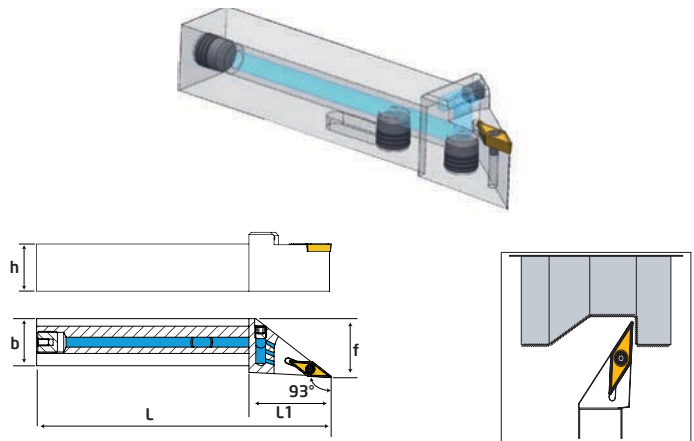

Product Code Produkt-Code	Dimensions(mm) Abmessungen (mm)						Insert WSP	Clamp Screw Torx- Schraube	im U-Platte	Shim Screw U-Platte Schraube	Torx Key Torx-Schlüssel
	L	L1	h	f	b	kg					
SVJCL 1616 H11- IK G1/8	100	25	16	20	16	0,204			---	---	
SVJCL 2020 K11- IK G1/8	125	33	20	25	20	0,378	VCMT 1103	SW-SS-12	---	---	T8
SVJCL 2020 K16- IK G1/8	125	33	20	25	20	0,385	VCMT 1604	SW-SS-10	SW-UP-22	SW-GB-1	T15
SVJCL 2525 M16- IK G1/8	150	40	25	32	25	0,683	VCMT 1604	SW-SS-10	SW-UP-22	SW-GB-1	T15

External Turning Holders With Coolant

95° PCLNR IC

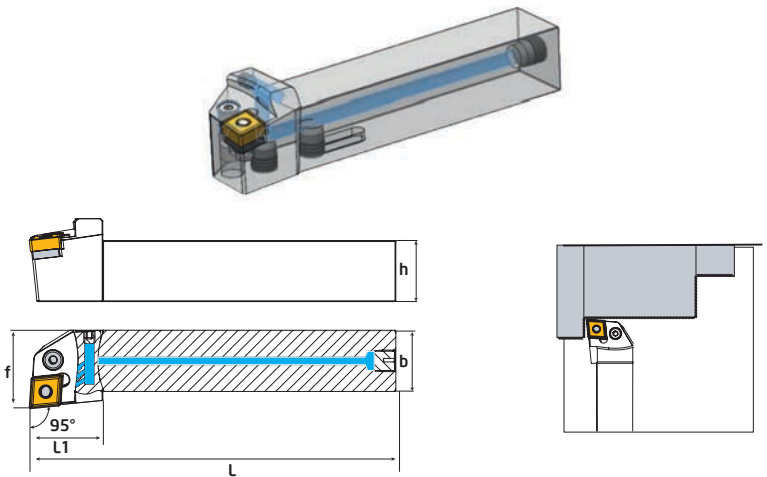

Product Code Produkt-Code	Dimensions(mm) Abmessungen (mm)						Insert WSP	Clamp Screw Klemm- Schraube	Shim U-Platte	Lock Pin Rohrstift	Lever Kniehebel	Allen Key In- buss-Schlüs- sel	
	L	L1	h	f	b	kg							
PCLNR 1616 H12- IK G1/8	100	28	16	20	16	0,236	CNMG 1204	SW-SS-1	SW-UP-2	SW-RS-2	SW-KH-1	3 Mm	
PCLNR 2020 K12 - IK G1/8	125	28	20	25	20	0,428			CNMG 1204	SW-UP-2	SW-RS-2		SW-KH-1
PCLNR 2525 M12 - IK G1/8	150	30	25	32	25	0,781				SW-UP-2	SW-RS-2		SW-KH-1

External Turning Holders With Coolant

95° PCLNL IC

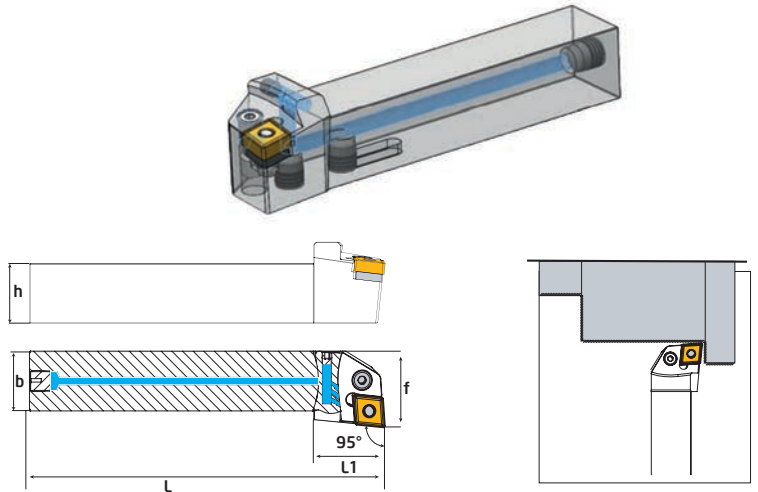

Product Code Produkt-Code	Dimensions(mm) Abmessungen (mm)						Insert WSP	Clamp Screw Klemm- Schraube	Shim U-Platte	Lock Pin Rohrstift	Lever Kniehebel	Allen Key	
	L	L1	h	f	b	kg							
PCLNL 1616 H12 - IK G1/8	100	28	16	20	16	0,236	CNMG 1204	SW-SS-1	SW-UP-2	SW-RS-2	SW-KH-1	3 Mm	
PCLNL 2020 K12 - IK G1/8	125	28	20	25	20	0,428			CNMG 1204	SW-UP-2	SW-RS-2		SW-KH-1
PCLNL 2525 M12 - IK G1/8	150	30	25	32	25	0,781				SW-UP-2	SW-RS-2		SW-KH-1

- External Turning Holders Coolant
- Klemmhalter Gekühlt

### External Turning Holders With Coolant 93° PDJNR IC

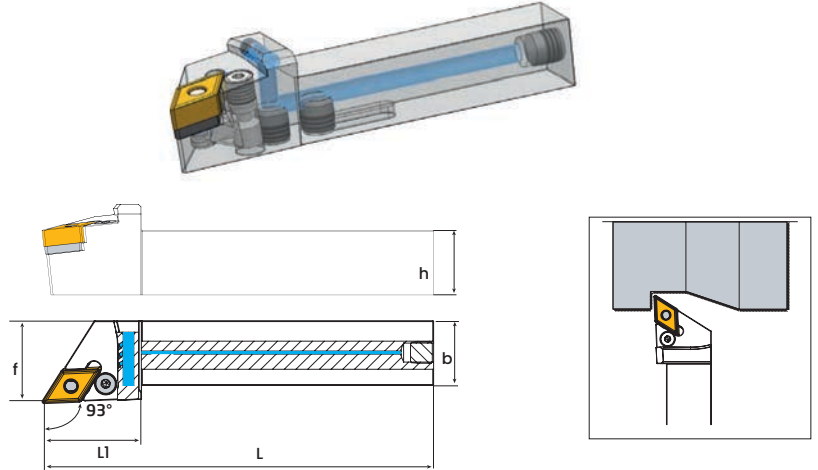

Product Code Produkt-Code	Dimensions(mm) Abmessungen (mm)						Insert WSP	Clamp Screw Klemm- Schraube	Shim U-Platte	Lock Pin Rohrstift	Lever Kniehe- bel	Allen Key Inbuss-Schlüssel
	L	L1	h	f	b	⊙						
PDJNR 2020 K15-ICG1/8	125	40	20	25	20	0,409						
PDJNR 2525 M15-ICG1/8	150	40	25	32	25	0,759						3mm

### External Turning Holders With Coolant

### 95° PWLNR 08 IC

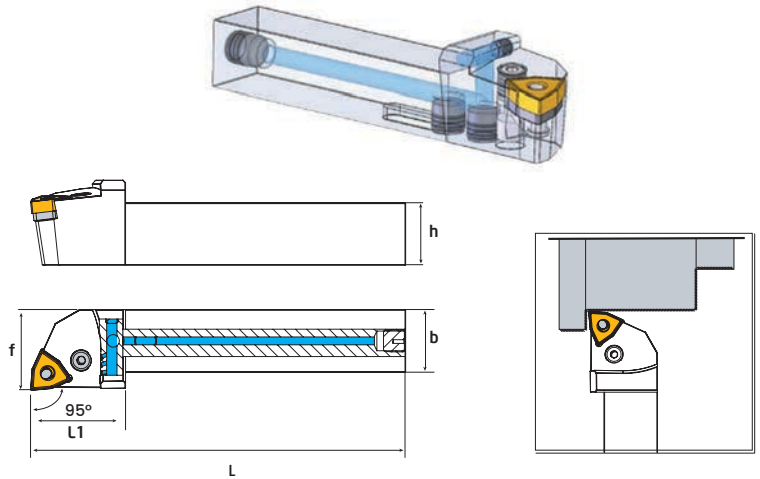

Product Code Produkt-Code	Dimensions(mm) Abmessungen (mm)						Insert WSP	Clamp Screw Klemm Schraube	Shim U-Platte	Lock Pin Rohrstift	Lever Kniehebel	Allen Key Inbuss-Schlüssel
	L	L1	h	f	b	⊙						
PWLNR 2020 K08-ICG1/8	125	30	20	25	20	0,425						
PWLNR 2525 M08-ICG1/8	150	38	25	32	25	0,782						3mm

External Turning Holders With Coolant

95° PWLNL 08 IC

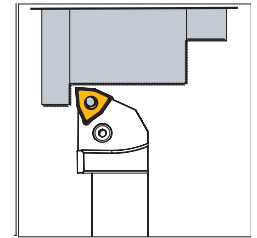
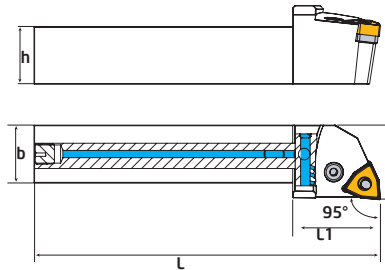
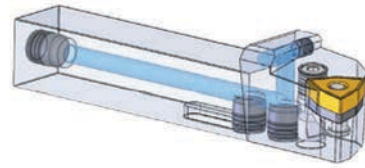

Product Code Produkt-Code	Dimensions(mm) Abmessungen (mm)						Insert WSP	Clamp Screw Klemm- Schraube	Shim U-Platte	Lock Pin Rohrstift	Lever Kniehe- bel	Allen Key Inbuss-Schlüssel
	L	L1	h	f	b	kg						
PWLNL 2020 K08-ICG1/8	125	30	20	25	20	0,425						
PWLNL 2525 M08-ICG1/8	150	38	25	32	25	0,782	WNMG 0804	SW-SS-1	SW- UP-12	SW- RS-2	SW-KH-1	3mm

# S System External Turning Holders

## S System Klemmhalter



### 95° SCLCR

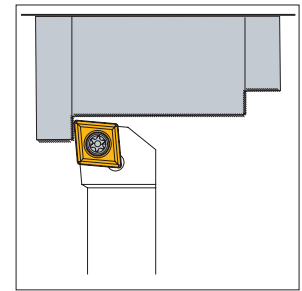
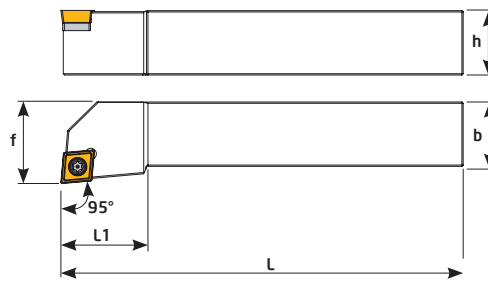

Product Code Produkt-Code	Dimensions(mm) Abmessungen (mm)						Insert WSP	Clamp Screw Torx-Schraube	Shim U-Platte	Shim Screw U-Platte Schraube	Torx Key Torx-Schlüssel
	L	L1	h	f	b	kg					
SCLCR 1010 J06	110	10	10	12	10	0,105		SW-SS-12	---	---	T8
SCLCR 1212 J09	110	16	12	16	12	0,140		SW-SS-10			
SCLCR 1616 H09	100	20	16	20	16	0,215	CC-- 09T3	SW-SS-10	SW-UP-14	SW-GB-1	T15
SCLCR 2020 K09	125	25	20	25	20	0,425					
SCLCR 2525 M09	150	25	25	32	25	0,772					
SCLCR 2020 K12	125	25	20	25	20	0,421	CC-- 1204	SW-SS-11	SW-UP-15	SW-GB-2	
SCLCR 2525 M12	150	25	25	32	25	0,768					

### 95° SCLCL

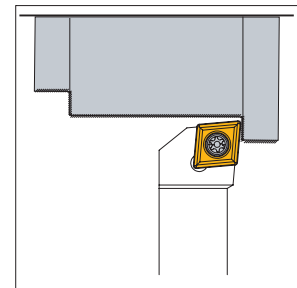
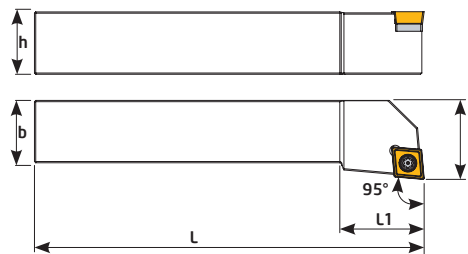



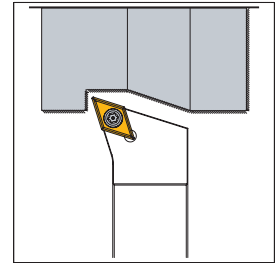
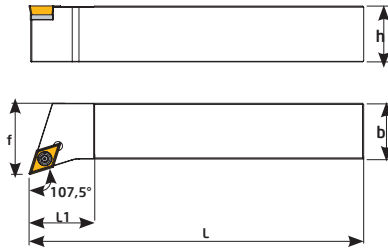

Product Code Produkt-Code	Dimensions(mm) Abmessungen (mm)						Insert WSP	Clamp Screw Torx-Schraube	Shim U-Platte	Shim Screw U-Platte Schraube	Torx Key Torx-Schlüssel
	L	L1	h	f	b	kg					
SCLCL 1010 J06	110	10	10	12	10	0,105		SW-SS-12	---	---	T8
SCLCL 1212 J09	110	16	12	16	12	0,140		SW-SS-10			
SCLCL 1616 H09	100	20	16	20	16	0,215	CC-- 09T3	SW-SS-10	SW-UP-14	SW-GB-1	T15
SCLCL 2020 K09	125	25	20	25	20	0,425					
SCLCL 2525 M09	150	25	25	32	25	0,772					
SCLCL 2020 K12	125	25	20	25	20	0,421	CC-- 1204	SW-SS-11	SW-UP-15	SW-GB-2	
SCLCL 2525 M12	150	25	25	32	25	0,768					

- S System External Turning Holders
- S System Klemmhalter



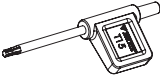

## 107,5° SDHCR

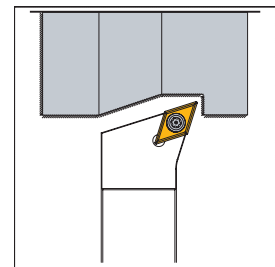
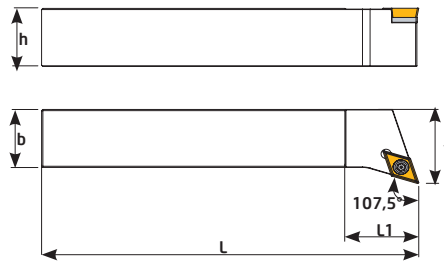

Product Code Produkt-Code	Dimensions(mm) Abmessungen (mm)						Insert WSP	Clamp Screw Torx- Schraube	Shim U-Platte	Shim Screw U-Platte Schraube	Torx Key Torx-Schlüssel
	L	L1	h	f	b	kg					
SDHCR 2020 K11	125	25	20	25	20	0,411					
SDHCR 2525 M11	150	25	25	32	25	0,738					





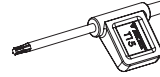

## 107,5° SDHCL

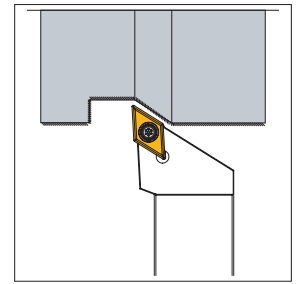
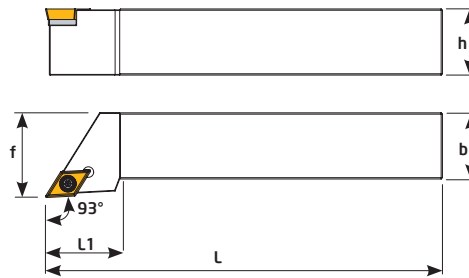

Product Code Produkt-Code	Dimensions(mm) Abmessungen (mm)						Insert WSP	Clamp Screw Torx- Schraube	Shim U-Platte	Shim Screw U-Platte Schraube	Torx Key Torx-Schlüssel
	L	L1	h	f	b	kg					
SDHCL 2020 K11	125	25	20	25	20	0,411					
SDHCL 2525 M11	150	25	25	32	25	0,738					

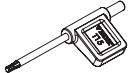





### 93° SDJCR

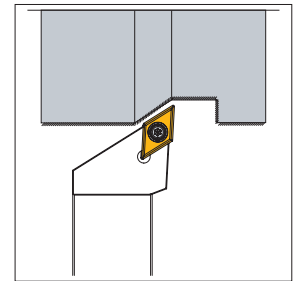
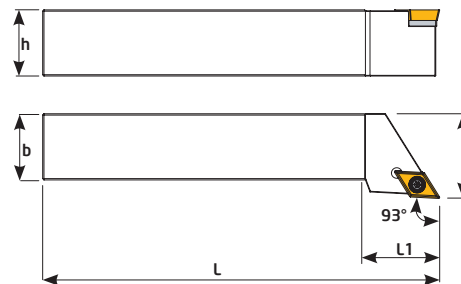

Product Code Produkt-Code	Dimensions(mm) Abmessungen (mm)						Insert WSP	Clamp Screw Torx- Schraube	Shim U-Platte	Shim Screw U-Platte Schraube	Torx Key Torx-Schlüssel	
	L	L1	h	f	b	⊖ kg						
SDJCR 1010 J07	110	15	10	12	10	0,097			---	---		
SDJCR 1212 J11	110	20	12	16	12	0,132						
SDJCR 1616 H11	100	25	16	20	16	0,204			---			T15
SDJCR 2020 K11	125	25	20	25	20	0,404						
SDJCR 2525 M11	150	30	25	32	25	0,735						

### 93° SDJCL









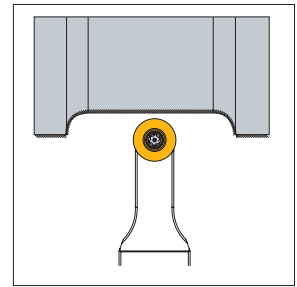
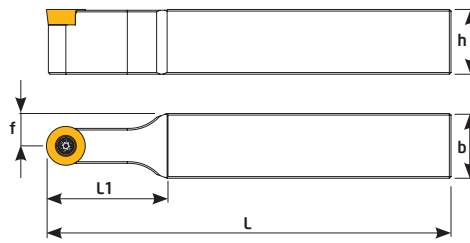

Product Code Produkt-Code	Dimensions(mm) Abmessungen (mm)						Insert WSP	Clamp Screw Torx- Schraube	Shim U-Platte	Shim Screw U-Platte Schraube	Torx Key Torx-Schlüssel
	L	L1	h	f	b	⊖ kg					
SDJCL 1010 J07	110	15	10	12	10	0,097			---	---	
SDJCL 1212 J11	110	20	12	16	12	0,132					
SDJCL 1616 H11	100	25	16	20	16	0,204					T15
SDJCL 2020 K11	125	25	20	25	20	0,404					
SDJCL 2525 M11	150	30	25	32	25	0,735					

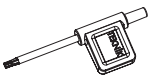
- S System External Turning Holders
- S System Klemmhalter





## SRDCN

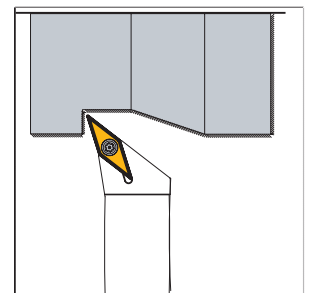
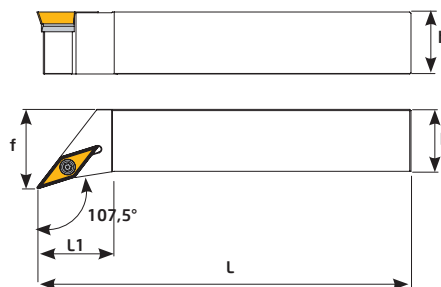

Product Code Produkt-Code	Dimensions(mm) Abmessungen (mm)						Insert WSP	Clamp Screw Torx-Schraube	Torx Key Torx-Schlüssel
	L	L1	h	f	b	kg			
SRDCN 2020 K08	125	37	20	10	20	0,358			
SRDCN 2525 M08	150	37	25	12.5	25	0,653			
SRDCN 2020 K10	125	35	20	10	20	0,370			
SRDCN 2525 M10	150	35	25	12.5	25	0,670			
SRDCN 2020 K12	125	38	20	10	20	0,372			
SRDCN 2525 M12	150	38	25	12.5	25	0,668			

## 107,5 SVHBR

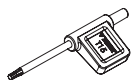

Product Code Produkt-Code	Dimensions(mm) Abmessungen (mm)						Insert WSP	Clamp Screw Torx-Schraube	Shim U-Platte	AShim Screw U-Platte Schraube	Torx Key Torx-Schlüssel
	L	L1	h	f	b	kg					
SVHBR 2020 K16	125	30	20	25	20	0,387					
SVHBR 2525 M16	150	30	25	32	25	0,712					

## 107,5 SVHBL

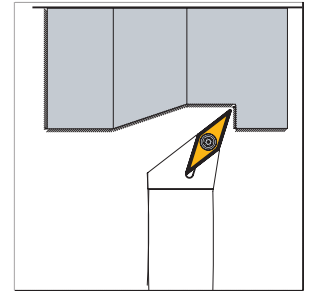
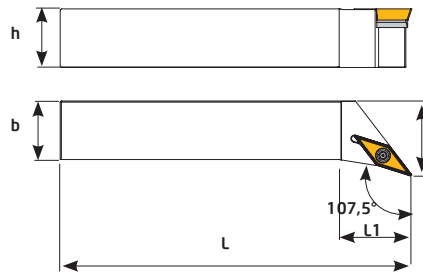

Product Code Produkt-Code	Dimensions (mm) Abmessungen (mm)						Insert WSP	Clamp Screw Torx-Schraube	Shim U-Platte	Shim Screw U-Platte Schraube	Torx Key Torx-Schlüssel
	L	L1	h	f	b	kg					
SVHBL 2020 K16	125	30	20	25	20	0,387	VBMT 1604	SW-SS-12	SW-UP-22	SW-GB-1	T15
SVHBL 2525 M16	150	30	25	32	25	0,712					

## 93° SVJBR

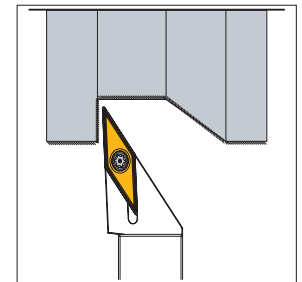
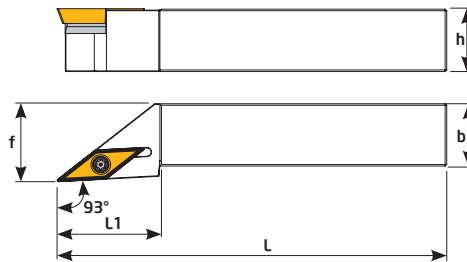

Product Code Produkt-Code	Dimensions (mm) Abmessungen (mm)						Insert WSP	Clamp Screw Torx-Schraube	Shim U-Platte	Shim Screw U-Platte Schraube	Torx Key Torx-Schlüssel
	L	L1	h	f	b	kg					
SVJBR 1616 H11	100	25	16	20	16	0,192	VBMT 1103	SW-SS-12	---	---	T8
SVJBR 2020 K16	125	33	20	25	20	0,382	VBMT 1604	SW-SS-10	SW-UP-22	SW-GB-1	T15
SVJBR 2525 M16	150	40	25	32	25	0,688					

### 93° SVJBL

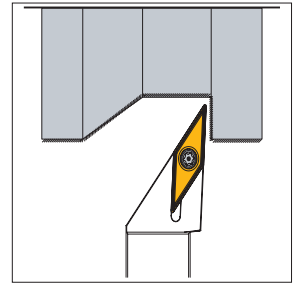
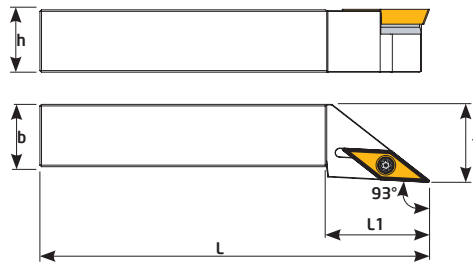

Product Code Produkt-Code	Dimensions(mm) Abmessungen (mm)						Insert WSP	Clamp Screw Torx- Schraube	Shim U-Platte	Shim Screw U-Platte Schraube	Torx Key Torx-Schlüssel
	L	L1	h	f	b	kg					
SVJBL 1616 H11	100	25	16	20	16	0,192	VBMT 1103	SW-SS-12	---	---	T8
SVJBL 2020 K16	125	33	20	25	20	0,382					
SVJBL 2525 M16	150	40	25	32	25	0,688					

### 93° SVJCR

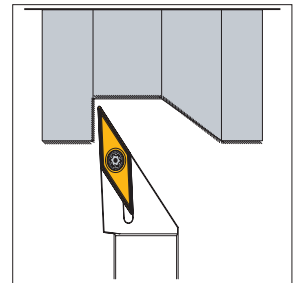
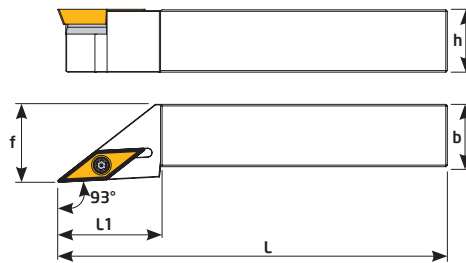

Product Code Produkt-Code	Dimensions(mm) Abmessungen (mm)						Insert WSP	Clamp Screw Torx- Schraube	Shim U-Platte	Shim Screw U-Platte Schraube	Torx Key Torx-Schlüssel
	L	L1	h	f	b	kg					
SVJCR 1212 J11	110	21	12	16	12	0,135	VCMT 1103	SW-SS-12	---	---	T8
SVJCR 1616 H11	100	25	16	20	16	0,204					
SVJCR 2020 K11	125	33	20	25	20	0,378					
SVJCR 2525 M11	150	40	25	32	25	0,738	VCMT 1604	SW-SS-10	SW-UP-22	SW-GB-1	T15
SVJCR 2020 K16	125	33	20	25	20	0,385					
SVJCR 2525 M16	150	40	25	32	25	0,683					

### 93° SVJCL

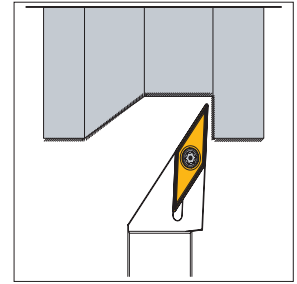
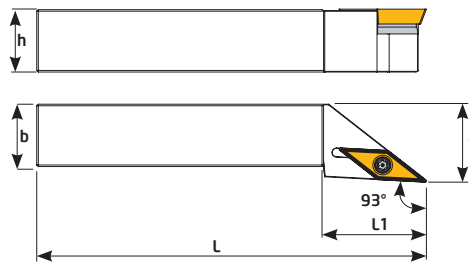

Product Code Produkt-Code	Dimensions(mm) Abmessungen (mm)						Insert WSP	Clamp Screw Torx-Schraube	Shim U-Platte	Shim Screw U-Platte Schraube	Torx Key Torx-Schlüssel
	L	L1	h	f	b	Ⓚg					
SVJCL 1212 J11	110	21	12	16	12	0,135	VCMT 1103	SW-SS-12	---	---	T8
SVJCL 1616 H11	100	25	16	20	16	0,204					
SVJCL 2020 K11	125	33	20	25	20	0,378					
SVJCL 2525 M11	150	40	25	32	25	0,738					
SVJCL 2020 K16	125	33	20	25	20	0,385	VCMT 1604	SW-SS-10	SW-UP-22	SW-GB-1	T15
SVJCL 2525 M16	150	40	25	32	25	0,683					

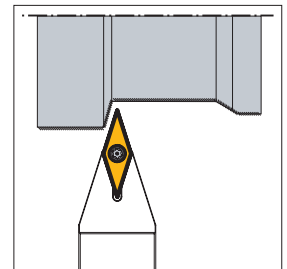
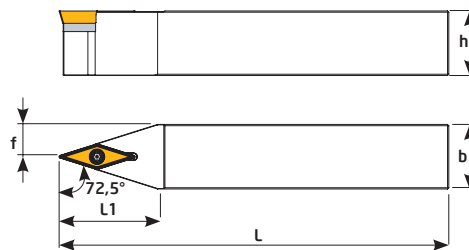

### 72,5° SVVBN

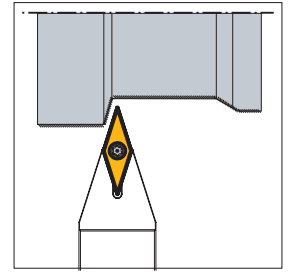
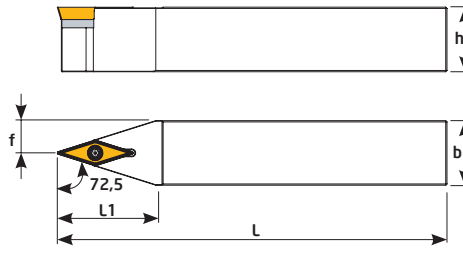

Product Code Produkt-Code	Dimensions(mm) Abmessungen (mm)						Insert WSP	Clamp Screw Torx-Schraube	Shim U-Platte	Shim Screw U-Platte Schraube	Torx Key Torx-Schlüssel
	L	L1	h	f	b	Ⓚg					
SVVBN 1212 J11	110	25	12	6	12	0,129	VBMT 1103	SW-SS-12	---	---	T8
SVVBN 2020 K16	125	35	20	10	20	0,370	VBMT 1604	SW-SS-10	SW-UP-22	SW-GB-1	T15
SVVBN 2525 M16	150	40	25	12,5	25	0,668					

## 72,5° SVVCN



Product Code Produkt-Code	Dimensions(mm) Abmessungen (mm)						Insert WSP	Clamp Screw Torx-Schraube	Shim U-Platte	Shim Screw U-Platte Schraube	Torx Key Torx-Schlüssel
	L	L1	h	f	b	kg					
SVVCN 1212 J11	110	22	12	6	12	0,127			---	---	
SVVCN 2020 K16	125	35	20	10	20	0,373	VCMT1604	SW-SS-10	SW-UP-22	SW-GB-1	T15
SVVCN 2525 M16	150	40	25	12,5	25	0,675					

### 93° MTJNR

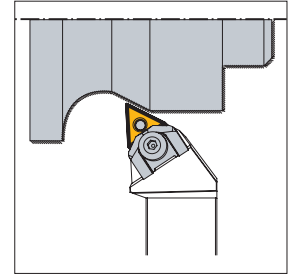
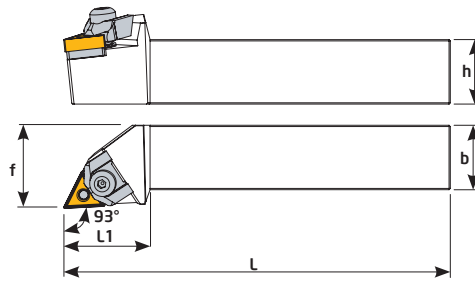

Product Code Produkt-Code	Dimensions(mm) Abmessungen (mm)						Insert WSP	Locking Screw Verriegelungs Schraube	Shim U-Platte	Lock Pin Rohrstift	Clamp Spann- pratze	Spring Feder	Washer U-Schei- be	Allen Key In- buss-Schlüs- sel
	L	L1	h	f	b	⊙								
MTJNR 2020 K16	125	35	20	25	20	0,429	TN-- 1604	TC046 M5	SW-UP-1	SW-RS-1	SW-KL-1	BY043	BSP031	3 Mm
MTJNR 2525 M16	150	35	25	32	25	0,760								

### 93° MTJNL

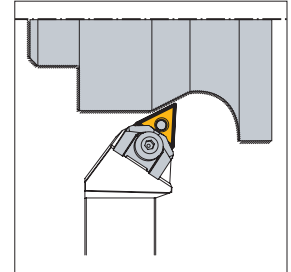
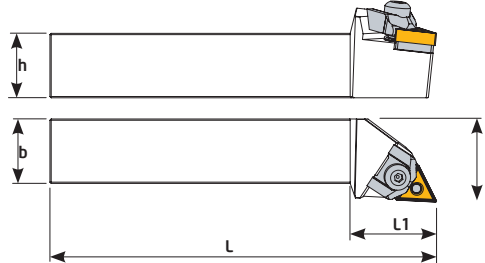

Product Code Produkt-Code	Dimensions(mm) Abmessungen (mm)						Insert WSP	Locking Screw Verriege- lungs Schraube	Shim U-Platte	Lock Pin Rohrstift	Clamp Spann- pratze	Spring Feder	Washer U-Schei- be	Allen Key Inbuss-Schlüs- sel
	L	L1	h	f	b	⊙								
MTJNL 2020 K16	125	35	20	25	20	0,429	TN-- 1604	TC046 M5	SW-UP-1	SW-RS-1	SW-KL-1	BY043	BSP031	3 Mm
MTJNL 2525 M16	150	35	25	32	25	0,760								

- P System External Turning Holders
- P System Klemmhalter

## 95° PCLNR

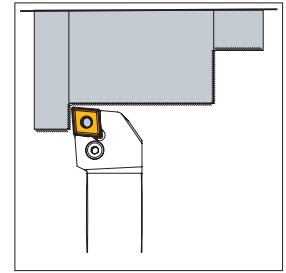
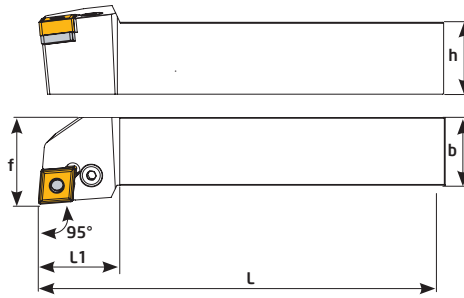

Product Code Produkt-Code	Dimensions(mm) Abmessungen (mm)						Insert WSP	Clamp Screw Klemm- Schraube	Shim U-Platte	Lock Pin Rohrstift	Lever Kniehe- bel	Allen Key Inbuss-Schlüssel
	L	L1	h	f	b	kg						
PCLNR 1616 H09	100	20	16	20	16	0,231	CNMG 09T3	SW-SS-6	SW-UP-3	SW-RS-5	SW-KH-8	2,5 Mm
PCLNR 2020 K09	125	22	20	25	20	0,428						
PCLNR 2525 M09	150	22	25	32	25	0,785						
PCLNR 1616 H12	100	30	16	20	16	0,225	CNMG 1204	SW-SS-1	SW-UP-2	SW-RS-2	SW-KH-1	3 Mm
PCLNR 2020 K12	125	30	20	25	20	0,421		SW-SS-1				
PCLNR 2525 M12	150	30	25	32	25	0,766						
PCLNR 3232 P12	170	30	32	40	32	1,429						

## 95° PCLNL

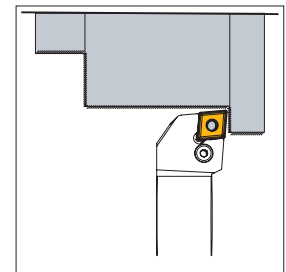
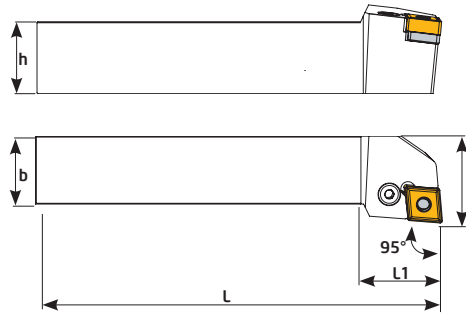

Product Code Produkt-Code	Dimensions(mm) Abmessungen (mm)						Insert WSP	Clamp Screw Klemm- Schraube	Shim U-Platte	Lock Pin Rohrstift	Lever Kniehe- bel	Allen Key Inbuss-Schlüssel
	L	L1	h	f	b	kg						
PCLNL 1616 H09	100	20	16	20	16	0,231	CNMG 09T3	SW-SS-6	SW-UP-3	SW-RS-5	SW-KH-8	2,5 Mm
PCLNL 2020 K09	125	22	20	25	20	0,428						
PCLNL 2525 M09	150	22	25	32	25	0,785						
PCLNL 1616 H12	100	30	16	20	16	0,225	CNMG 1204	SW-SS-1	SW-UP-2	SW-RS-2	SW-KH-1	3 Mm
PCLNL 2020 K12	125	30	20	25	20	0,421		SW-SS-1				
PCLNL 2525 M12	150	30	25	32	25	0,766						
PCLNL 3232 P12	170	30	32	40	32	1,429						

### 93° PDJNR

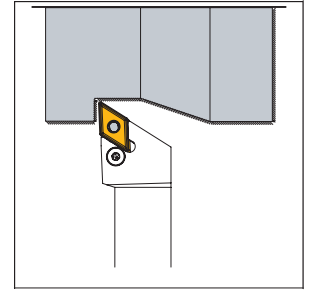
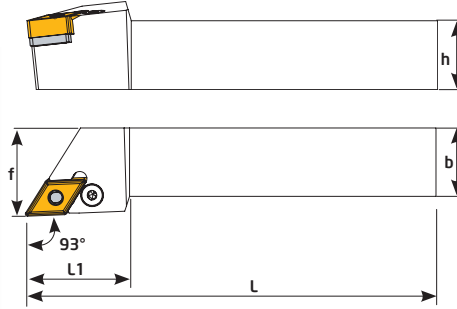

Product Code Produkt-Code	Dimensions(mm) Abmessungen (mm)						Insert WSP	Clamp Screw Klemm- Schraube	Shim U-Platte	Lock Pin Rohrstift	Lever Kniehebel	Allen Key In- buss-Schlüs- sel
	L	L1	h	f	b	kg						
PDJNR 1616 H11	100	25	16	25	16	0,242	DNMG 1104	SW-SS-6	SW-UP-6	SW-RS-5	SW-KH-8	2,5 Mm
PDJNR 2020 K11	125	30	20	25	20	0,435		SW-SS-6				
PDJNR 2525 M11	150	30	25	32	25	0,767						
PDJNR 2020 K15	125	35	20	25	20	0,402	DNMG 1506	SW-SS-1	SW-UP-7	SW-RS-2	SW-KH-1B	3 Mm
PDJNR 2525 M15	150	38	25	32	25	0,730		SW-SS-1				
PDJNR 3232 P15	170	38	32	40	32	1,384						

### 93° PDJNL

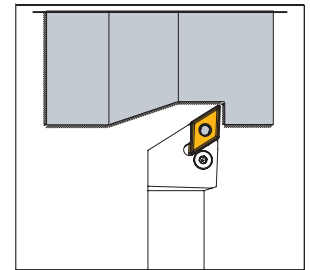
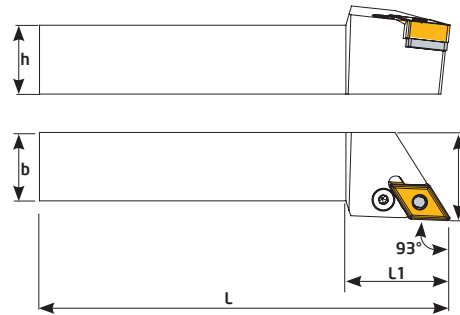

Product Code Produkt-Code	Dimensions(mm) Abmessungen (mm)						Insert WSP	Clamp Screw Klemm- Schraube	Shim U-Platte	Lock Pin Rohrstift	Lever Kniehebel	Allen Key Inbuss-Schlüssel
	L	L1	h	f	b	kg						
PDJNL 1616 H11	100	25	16	25	16	0,242	DNMG 1104	SW-SS-6	SW-UP-6	SW-RS-5	SW-KH-8	2,5 Mm
PDJNL 2020 K11	125	30	20	25	20	0,435		SW-SS-6				
PDJNL 2525 M11	150	30	25	32	25	0,767						
PDJNL 2020 K15	125	35	20	25	20	0,402	DNMG 1506	SW-SS-1	SW-UP-7	SW-RS-2	SW-KH-1B	3 Mm
PDJNL 2525 M15	150	38	25	32	25	0,730		SW-SS-1				
PDJNL 3232 P15	170	38	32	40	32	1,384						

- P System External Turning Holders
- P System Klemmhalter

## 45° PSSNR

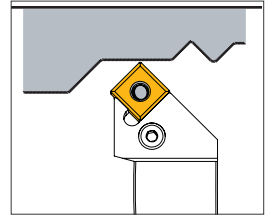
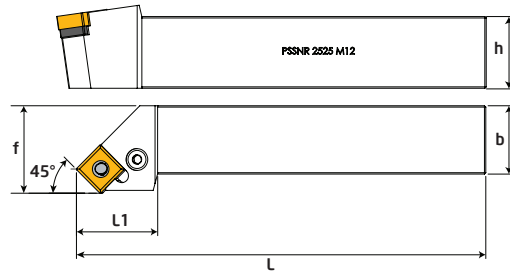

Product Code Produkt-Code	Dimensions(mm) Abmessungen (mm)						Insert WSP	Clamp Screw Klemm- Schraube	Shim U-Platte	Lock Pin Rohrstift	Lever Kniehebel	Allen Key Inbuss-Schlüssel
	L	L1	h	f	b	kg						
PSSNR 1616 H12	100	30	16	20	16	0,218	SNMG 1204	SW-SS-1	SW-UP-8	SW-RS-2	SW-KH-1	3 Mm
PSSNR 2525 M12	150	30	25	32	25	0,742		SW-SS-1				

## 45° PSSNL

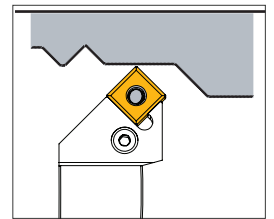
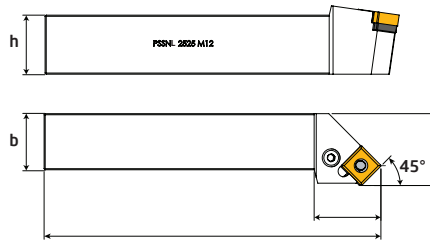

Product Code Produkt-Code	Dimensions(mm) Abmessungen (mm)						Insert WSP	Clamp Screw Klemm- Schraube	Shim U-Platte	Lock Pin Rohrstift	Lever Kniehebel	Allen Key Inbuss-Schlüssel
	L	L1	h	f	b	kg						
PSSNL 2020 K12	125	30	20	25	20	0,416	SNMG 1204	SW-SS-1	SW-UP-8	SW-RS-2	SW-KH-1	3 Mm
PSSNL 2525 M12	150	30	25	32	25	0,742		SW-SS-1				

### 95° PWLNR 06

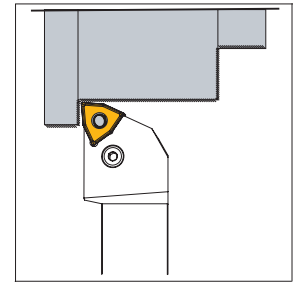
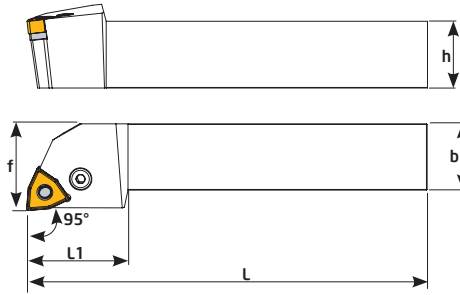

Product Code Produkt-Code	Dimensions (mm) Abmessungen (mm)						Insert WSP	Clamp Screw Klemm- Schraube	Shim U-Platte	Lock Pin Rohrstift	Lever Kniehebel	Allen Key Inbuss- Schlüssel
	L	L1	h	f	b	kg						
PWLNR 1616 H06	100	30	16	20	16	0,223	WNMG 0604	SW-SS-6	TA021	SW-RS-5	SW-KH-8	2,5 Mm
PWLNR 2020 K06	125	30	20	25	20	0,429						
PWLNR 2020 K08	125	30	20	25	20	0,430	WNMG 0804	SW-SS-1	TA020-1	SW-RS-2	SW-KH-1	3 Mm
PWLNR 2525 M06	150	30	25	32	25	0,758	WNMG 0604	SW-SS-6	TA021	SW-RS-5	SW-KH-8	2,5 Mm
PWLNR 2525 M08	150	38	25	32	25	0,773	WNMG 0804	SW-SS-1	TA020-1	SW-RS-2	SW-KH-1	3 Mm
PWLNR 3232 P08	170	38	32	40	32	1,421						

### 95° PWLNL 06

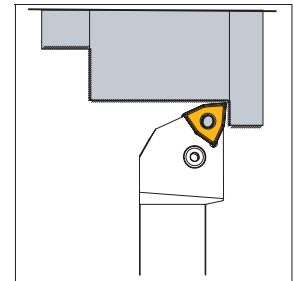
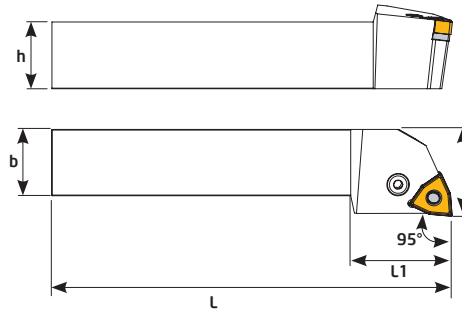

Product Code Produkt-Code	Dimensions (mm) Abmessungen (mm)						Insert WSP	Clamp Screw Klemm- Schraube	Shim U-Platte	Lock Pin Rohrstift	Lever Kniehebel	Allen Key Inbuss- Schlüssel
	L	L1	h	f	b	kg						
PWLNL 1616 H06	100	30	16	20	16	0,223	WNMG 0604	SW-SS-6	TA021	SW-RS-5	SW-KH-8	2,5 Mm
PWLNL 2020 K06	125	30	20	25	20	0,429						
PWLNL 2020 K08	125	30	20	25	20	0,430	WNMG 0804	SW-SS-1	TA020-1	SW-RS-2	SW-KH-1	3 Mm
PWLNL 2525 M06	150	30	25	32	25	0,758	WNMG 0604	SW-SS-6	TA021	SW-RS-5	SW-KH-8	2,5 Mm
PWLNL 2525 M08	150	38	25	32	25	0,773	WNMG 0804	SW-SS-1	TA020-1	SW-RS-2	SW-KH-1	3 Mm
PWLNL 3232 P08	170	38	32	40	32	1,421						

- AS System / S System Boring Bars
- AS System / S System Bohrstange

### 95° SCLCR IC

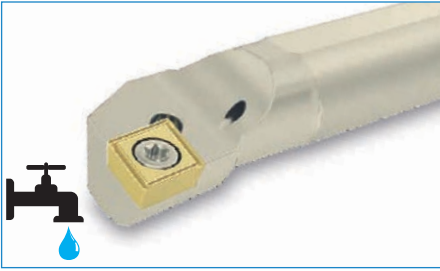

### Boring Bars With Coolant

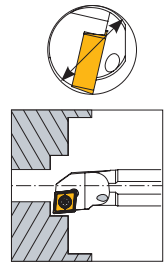
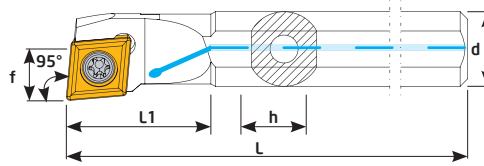

Product Code	Dimensions(mm) Abmessungen (mm)							Insert WSP	Clamp Screw Torx-Schraube	Torx Key Torx-Schlüssel
	Dmin	d	L	L1	f	h				
A08H SCLCR 06	10	8	100	16	5,5	7	0,050			
A10J SCLCR 06	12	10	110	20	6	9	0,074			
A12K SCLCR 06	16	12	125	25	9	11	0,113			
A16Q SCLCR 09	20	16	180	30	11	15	0,260			
A20Q SCLCR 09	25	20	180	40	13	18	0,422			

### Boring Bars With Coolant



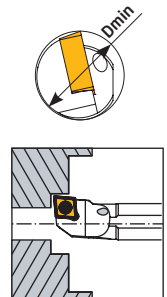
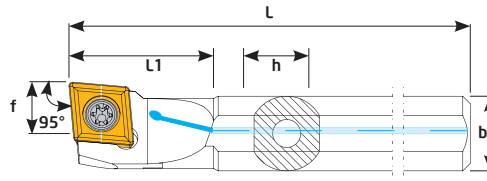



### 95° SCLCL IC

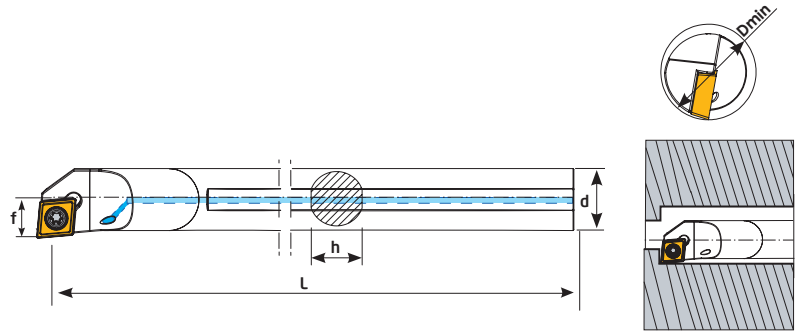

Product Code Produkt-Code	Dimensions(mm) Abmessungen (mm)							Insert WSP	Clamp Screw Torx-Schraube	Torx Key Torx-Schlüssel
	Dmin	d	L	L1	f	h				
A08H SCLCL 06	10	8	100	16	5,5	7	0,050			
A10J SCLCL 06	12	10	110	20	6	9	0,074			
A12K SCLCL 06	16	12	125	25	9	11	0,113			
A16Q SCLCL 09	20	16	180	30	11	15	0,260			
A20Q SCLCL 09	25	20	180	40	13	18	0,422			

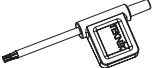



### 95° E-SCLCR IC

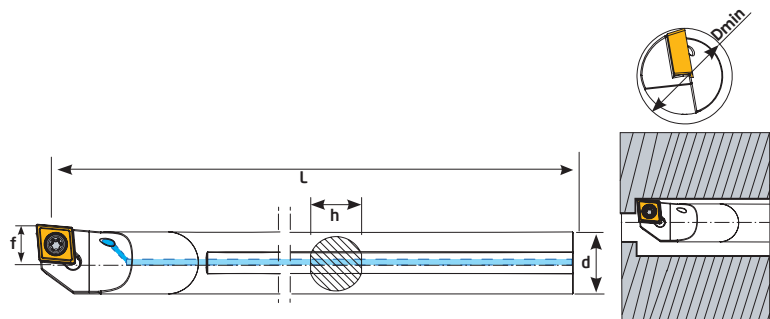

Product Code Produkt-Code	Dimensions(mm) Abmessungen (mm)						Insert WSP	Clamp Screw Torx-Schraube	Torx Key Torx-Schlüssel
	Dmin	d	L	f	h	kg			
E08K SCLCR 06	10	8	125	5	7,5	0,050	 CC-- 0602	 SW-SS-16	 T8
E10K SCLCR 06	12	10	125	6	9,5	0,100			
E12M SCLCR 06	16	12	150	7	11,5	0,200			
E16R SCLCR 09	20	16	200	10	15,5	0,500	 CCMT 09T3	 SW-SS-17	 T15
E20S SCLCR 09	25	20	250	13	19,5	0,950			

### 95° E-SCLCL IC

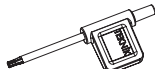

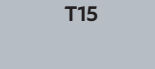
Product Code Produkt-Code	Dimensions(mm) Abmessungen (mm)						Insert WSP	Clamp Screw Torx-Schraube	Torx Key Torx-Schlüssel
	Dmin	d	L	f	h	kg			
E08K SCLCL 06	10	8	125	5	7,5	0,050	 CC-- 0602	 SW-SS-16	 T8
E10K SCLCL 06	12	10	125	6	9,5	0,100			
E12M SCLCL 06	16	12	150	7	11,5	0,200			
E16R SCLCL 09	20	16	200	10	15,5	0,500	 CCMT 09T3	 SW-SS-17	 T15
E20S SCLCL 09	25	20	250	13	19,5	0,950			

- AS System / S System Boring Bars
- AS System / S System Bohrstange

### 93° SDUCR IC



### Boring Bars With Coolant

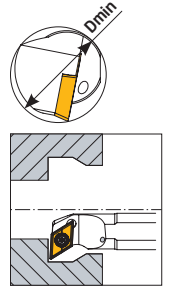
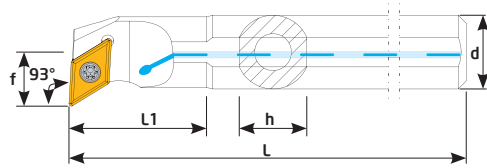

Product Code Produkt-Code	Dimensions(mm) Abmessungen (mm)							Insert WSP	Clamp Screw Torx-Schraube	Torx Key Torx-Schlüssel
	Dmin	d	L	L1	f	h	⊕			
A10J SDUCR 07	12	10	110	20	7	9	0,080			
A12K SDUCR 07	16	12	125	25	9	11	0,120			
A16Q SDUCR 07	20	16	180	30	11	15	0,263			
A20Q SDUCR 11	25	20	180	32	13	18	0,432			
A25R SDUCR 11	32	25	200	40	17	23	0,746			
A32T SDUCR 11	40	32	300	45	22	30	1,924			

### 93° SDUCL IC



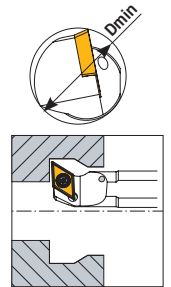
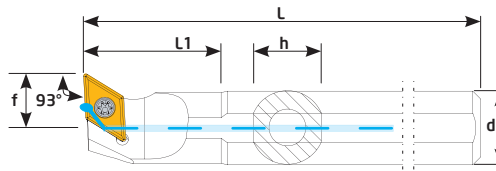

### Boring Bars With Coolant

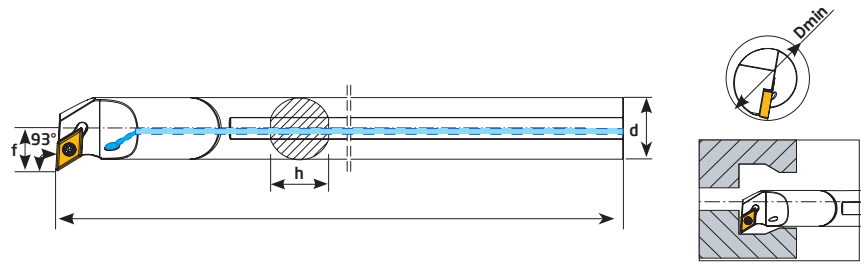

Product Code Produkt-Code	Dimensions(mm) Abmessungen (mm)							Insert WSP	Clamp Screw Torx-Schraube	Torx Key Torx-Schlüssel
	Dmin	d	L	L1	f	h	⊕			
A10J SDUCL 07	12	10	110	20	7	9	0,080			
A12K SDUCL 07	16	12	125	25	9	11	0,120			
A16Q SDUCL 07	20	16	180	30	11	15	0,263			
A20Q SDUCL 11	25	20	180	32	13	18	0,432			
A25R SDUCL 11	32	25	200	40	17	23	0,746			
A32T SDUCL 11	40	32	300	45	22	30	1,924			

### 93° E-SDUCR IC

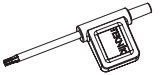

Product Code Produkt-Code	Dimensions(mm) Abmessungen (mm)						Insert WSP	Clamp Screw Torx-Schraube	Torx Key Torx-Schlüssel
	Dmin	d	L	f	h	⊙			
E10K SDUCR 07	13	10	125	7	9,5	0,050			
E12M SDUCR 07	16	12	150	9	11,5	0,100			
E16R SDUCR 07	20	16	200	11	15,5	0,200			
E20S SDUCR 11	25	20	250	13	19,5	0,950			

### 93° E-SDUCL IC

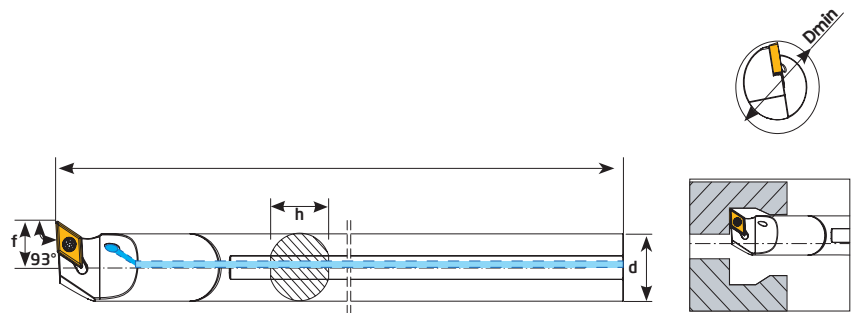



Product Code Produkt-Code	Dimensions(mm) Abmessungen (mm)						Insert WSP	Clamp Screw Torx-Schraube	Torx Key Torx-Schlüssel
	Dmin	d	L	f	h	⊙			
E10K SDUCL 07	13	10	125	7	9,5	0,050			
E12M SDUCL 07	16	12	150	9	11,5	0,100			
E16R SDUCL 07	20	16	200	11	15,5	0,200			
E20S SDUCL 11	25	20	250	13	19,5	0,950			

### 107,5° SDQCR IC

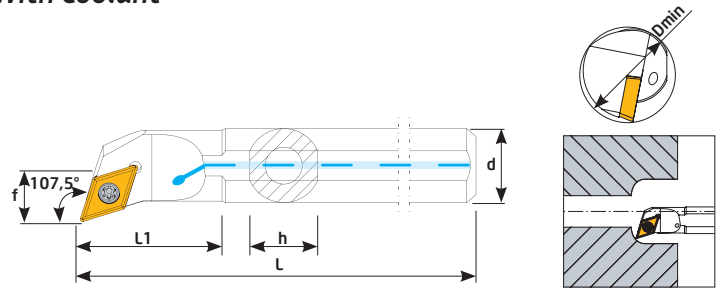
### Boring Bars With Coolant



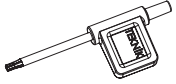

Product Code Produkt-Code	Dimensions(mm) Abmessungen (mm)							Insert WSP	Clamp Screw Torx-Schraube	Torx Key Torx-Schlüssel
	Dmin	d	L	L1	f	h	kg			
A10J SDQCR 07	12	10	110	20	7	9	0,074			
A12K SDQCR 07	16	12	125	25	9	11	0,110			
A16Q SDQCR 07	20	16	180	30	11	15	0,282			
A20Q SDQCR 11	25	20	180	32	13	18	0,425	DC--11T3	SW-SS-17	T15
A25R SDQCR 11	32	25	200	40	17	23	0,738			

### 107,5° SDQCL IC

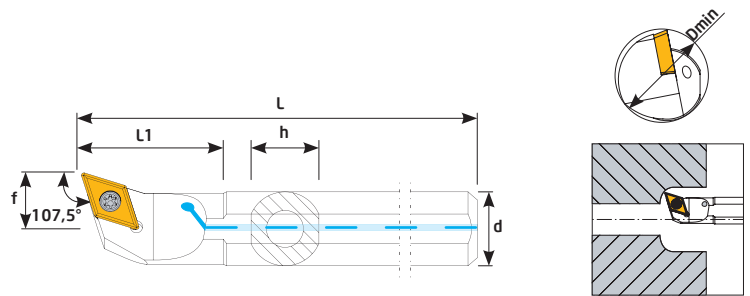
### Boring Bars With Coolant

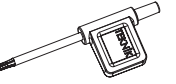

Product Code Produkt-Code	Dimensions(mm) Abmessungen (mm)							Insert WSP	Clamp Screw Torx-Schraube	Torx Key Torx-Schlüssel
	Dmin	d	L	L1	f	h	kg			
A10J SDQCL 07	12	10	110	20	7	9	0,074			
A12K SDQCL 07	16	12	125	25	9	11	0,110			
A16Q SDQCL 07	20	16	180	30	11	15	0,282			
A20Q SDQCL 11	25	20	180	32	13	18	0,425	DC--11T3	SW-SS-17	T15
A25R SDQCL 11	32	25	200	40	17	23	0,738			

### 107,5° E-SDQCR IC

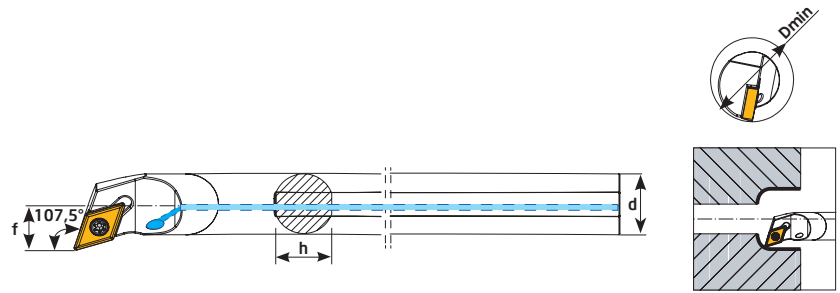

Product Code Produkt-Code	Dimensions(mm) Abmessungen (mm)						Insert WSP	Clamp Screw Torx-Schraube	Torx Key Torx-Schlüssel
	Dmin	d	L	f	h				
E10K SDQCR 07	13	10	125	7	9,5	0,050			
E12M SDQCR 07	16	12	150	9	11,5	0,100			
E16R SDQCR 07	20	16	200	11	15,5	0,200			
E20S SDQCR 11	25	20	250	13	19,5	0,950	DCMT 11T3	SW-SS-17	T15

### 107,5° E-SDQCL IC

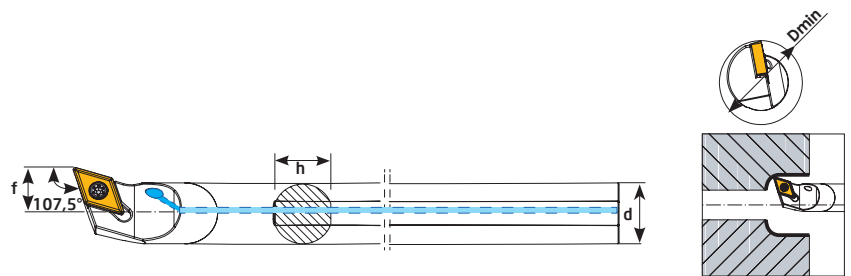



Product Code Produkt-Code	Dimensions(mm) Abmessungen (mm)						Insert WSP	Clamp Screw Torx-Schraube	Torx Key Torx-Schlüssel
	Dmin	d	L	f	h				
E10K SDQCL 07	13	10	125	7	9,5	0,050			
E12M SDQCL 07	16	12	150	9	11,5	0,100			
E16R SDQCL 07	20	16	200	11	15,5	0,200			
E20S SDQCL 11	25	20	250	13	19,5	0,950	DCMT 11T3	SW-SS-17	T15

### 90° STFCR IC

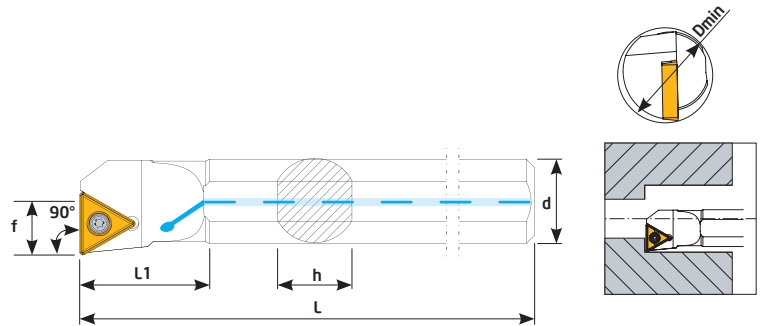
### Boring Bars With Coolant



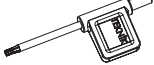

Product Code Produkt-Code	Dimensions(mm) Abmessungen (mm)							Insert WSP	Clamp Screw Torx-Schraube	Torx Key Torx-Schlüssel
	Dmin	d	L	L1	f	h	kg			
A12K STFCR 11	16	12	125	25	9	11	0,053	TCMT 1102	SW-SS-16	T8
A16Q STFCR 11	20	16	180	30	11	15	0,289	TCMT 16T3	SW-SS-17	T15
A20Q STFCR 16	25	20	180	32	13	18	0,440			
A25R STFCR 16	32	25	200	40	16	23	0,754			

### 90° STFCL IC

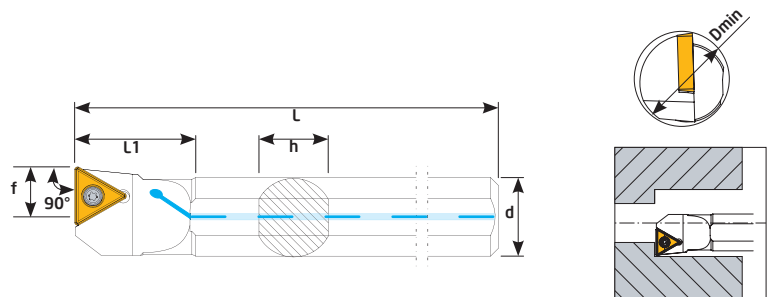
### Boring Bars With Coolant



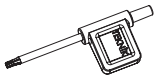

Product Code Produkt-Code	Dimensions(mm) Abmessungen (mm)							Insert WSP	Clamp Screw Torx-Schraube	Torx Key Torx-Schlüssel
	Dmin	d	L	L1	f	h	kg			
A12K STFCL 11	16	12	125	25	9	11	0,053	TCMT 1102	SW-SS-16	T8
A16Q STFCL 11	20	16	180	30	11	15	0,289	TCMT 16T3	SW-SS-17	T15
A20Q STFCL 16	25	20	180	32	13	18	0,440			
A25R STFCL 16	32	25	200	40	16	23	0,754			

### 93° SVUBR IC

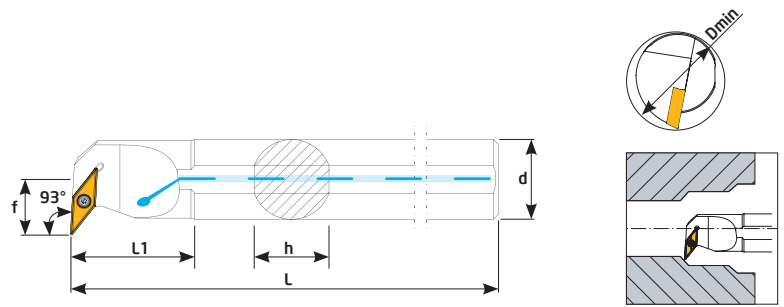
### Boring Bars With Coolant



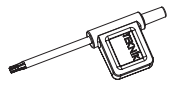

Product Code Produkt-Code	Dimensions(mm) Abmessungen (mm)							Insert WSP	Clamp Screw Torx-Schraube	Torx Key Torx-Schlüssel
	Dmin	d	L	L1	f	h	kg			
A25R SVUBR 16	32	25	200	40	17	23	0,723	VBMT 1604	SW-SS-17	T15
A32T SVUBR 16	40	32	300	50	22	30	1,909			

### Boring Bars With Coolant

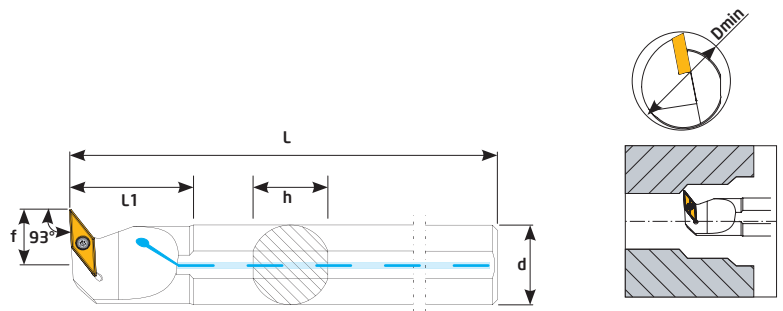
### 93° SVUBL IC

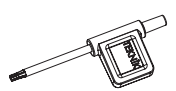

Product Code Produkt-Code	Dimensions(mm) Abmessungen (mm)							Insert WSP	Clamp Screw Torx-Schraube	Torx Key Torx-Schlüssel
	Dmin	d	L	L1	f	h	kg			
A25R SVUBL 16	32	25	200	40	17	23	0,723	VBMT 1604	SW-SS-17	T15
A32T SVUBL 16	40	32	300	50	22	30	1,909			

### 93° SVUCR IC

### Boring Bars With Coolant

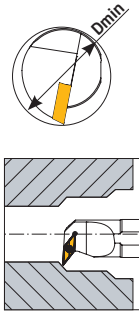
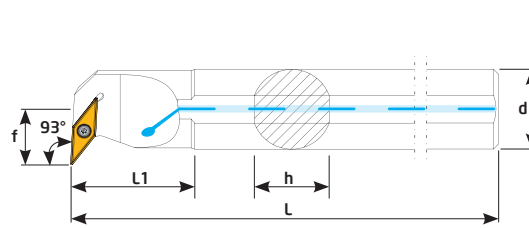

Product Code Produkt-Code	Dimensions(mm) Abmessungen (mm)							Insert WSP	Clamp Screw Torx-Schraube	Torx Key Torx-Schlüssel
	Dmin	d	L	L1	f	h	Ⓚg			
A16Q SVUCR 11	20	16	180	30	11	15	0,268	VCMT 1103	SW-SS-16	T8
A20Q SVUCR 11	25	20	180	32	13	18	0,689			
A25R SVUCR 16	32	25	200	40	17	23	0,720	VCMT 1604	SW-SS-17	T15
A32T SVUCR 16	40	32	300	50	22	30	1,812			

### 93° SVUCL IC

### Boring Bars With Coolant

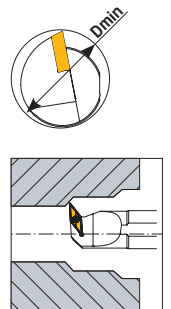
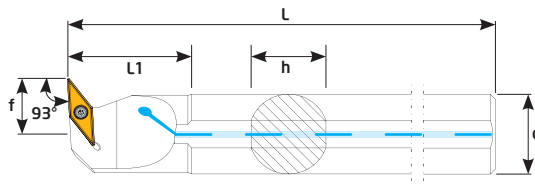
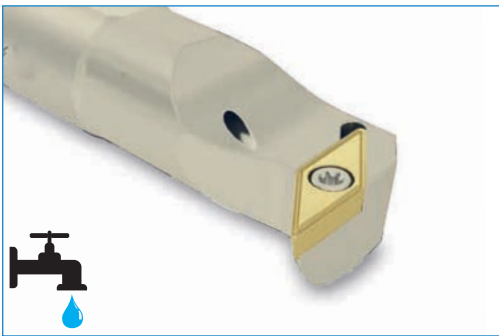

Product Code Produkt-Code	Dimensions(mm) Abmessungen (mm)							Insert WSP	Clamp Screw Torx-Schraube	Torx Key Torx-Schlüssel
	Dmin	d	L	L1	f	h	Ⓚg			
A16Q SVUCL 11	20	16	180	30	11	15	0,268	VCMT 1103	SW-SS-16	T8
A20Q SVUCL 11	25	20	180	32	13	18	0,689			
A25R SVUCL 16	32	25	200	40	17	23	0,720	VCMT 1604	SW-SS-17	T15
A32T SVUCL 16	40	32	300	50	22	30	1,812			

## Boring Bars With Coolant

### 95° PCLNR IC

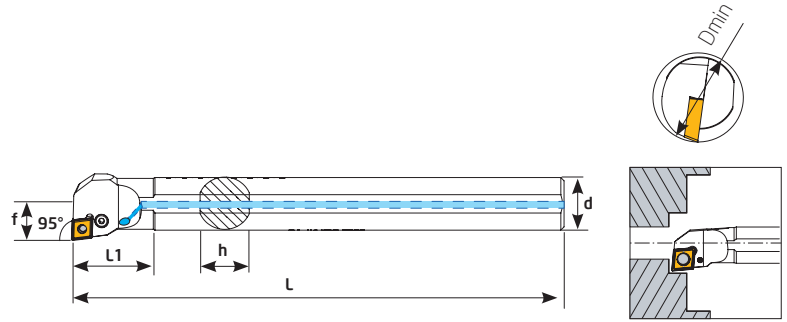

Product Code Produkt-Code	Dimensions(mm) Abmessungen (mm)							Insert WSP	Clamp Screw Klemm- Schraube	Shim U-Platte	Lock Pin Rohrstift	Lever Kniehebel	Allen Key Inbuss-Schlüs- sel
	Dmin	d	L	L1	f	h	⊙						
A20R PCLNR 12	24	20	200	50	13	18	0,520	CNMG1204	SW-SS-6	---	---	SW-KH-1A	2,5 Mm
A25S PCLNR 12	32	25	250	50	17	23	0,921						
A32T PCLNR 12	40	32	300	50	22	30	1,809		SW-SS-1	SW-UP-2	SW-RS-2	SW-KH-1	3 Mm
A40T PCLNR 12	50	40	300	55	27	38	1,820						

## Boring Bars With Coolant

### 95° PCLNL IC

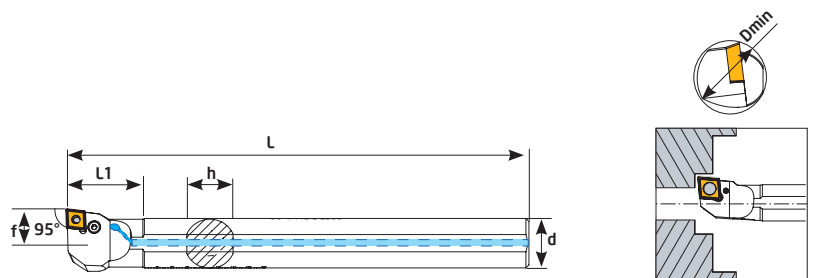

Sipariş Kodu Order Code Best.- Nr.	Stok/Stock/Lager	Product Code Produkt-Code	Dimensions(mm) Abmessungen (mm)							Insert WSP	Clamp Screw Klemm- Schraube	Shim U-Platte	Lock Pin Rohrstift	Lever Knie- hebel	Allen Key In- buss-Schlüs- sel
			Dmin	d	L	L1	f	h	⊙						
AP350	●	A25S PCLNL 12	32	25	250	50	17	23	0,921	CNMG 1204	SW-SS-6	---	---	SW- KH-1A	2,5 Mm
AP352	●	A32T PCLNL 12	40	32	300	50	22	30	1,809						
AP354	●	A40T PCLNL 12	50	40	300	55	27	38	1,820		SW-SS-1	SW- UP-2	SW-RS-2	SW- KH-1	3 Mm

- AP System / P System Boring Bars
- AP System / P System Bohrstange

### Boring Bars With Coolant

#### 93° PDUNR IC

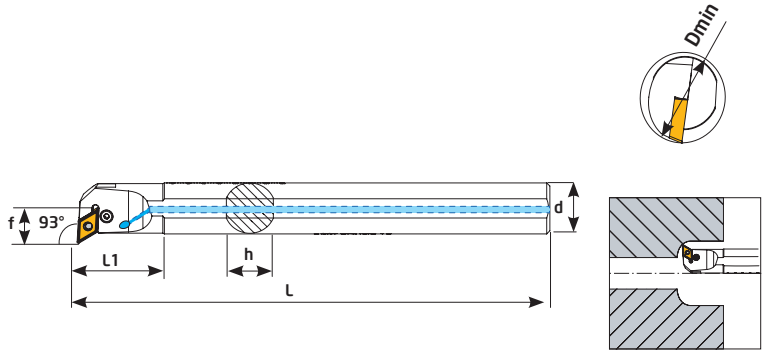

Product Code Produkt-Code	Dimensions(mm) Abmessungen (mm)							Insert WSP	Clamp Screw Klemm- Schraube	Shim U-Platte	Lock Pin Rohrstift	Lever Kniehebel	Allen Key Inbuss-Schlüssel
	Dmin	d	L	L1	f	h	kg						
A32T PDUNR 15	40	32	300	55	22	30	1,770						
A40T PDUNR 15	50	40	300	55	27	38	1,790						

### Boring Bars With Coolant

#### 93° PDUNL IC

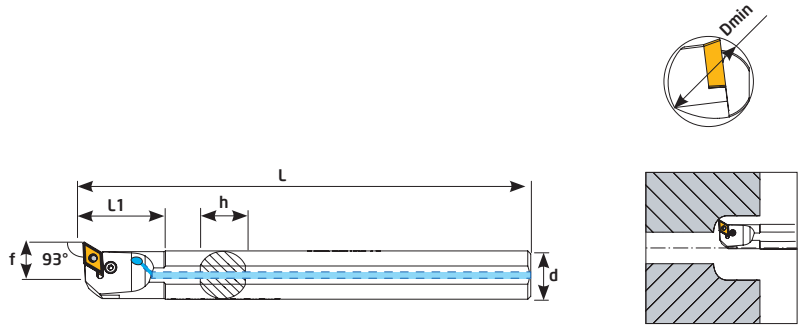

Product Code Produkt-Code	Dimensions(mm) Abmessungen (mm)							Insert WSP	Clamp Screw Klemm- Schraube	Shim U-Platte	Lock Pin Rohrstift	Lever Kniehe- bel	Allen Key In- buss-Schlüs- sel
	Dmin	d	L	L1	f	h	kg						
A32T PDUNL 15	40	32	300	55	22	30	1,770						
A40T PDUNL 15	50	40	300	55	27	38	1,790						

## Boring Bars With Coolant

### 95° PWLNR 06 IC

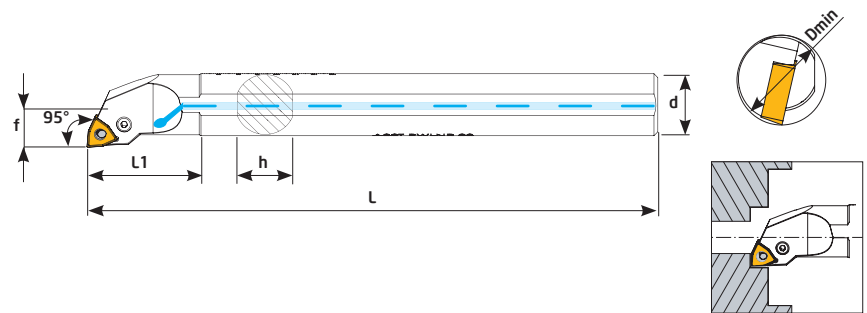

Sipariş Kodu Order Code Code Best.-Nr.	Stok/Stock/Lager	Product Code Produkt-Code	Dimensions(mm) Abmessungen (mm)							Insert WSP	Clamp Screw Klemm-Schraube	Lever Kniehebel	Allen Key Inbuss-Schlüssel
			Dmin	d	L	L1	f	h	⊙				
AP380	●	A16R PWLNR 06	20	16	200	40	11	15	0,326	WNMG 0604	SW-SS-8	SW-KH-8B	2 Mm
AP382	●	A20R PWLNR 06	25	20	200	40	13	18	0,471				
AP362	●	A32T PWLNR 08	40	32	300	60	22	30	1,764				

## Boring Bars With Coolant

### 95° PWLNL 06 IC

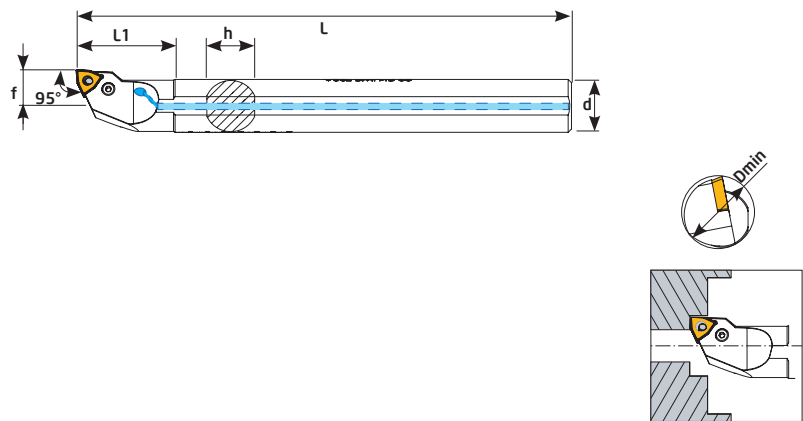

Product Code Produkt-Code	Dimensions(mm) Abmessungen (mm)							Insert WSP	Clamp Screw Klemm-Schraube	Lever Kniehebel	Allen Key Inbuss-Schlüssel
	Dmin	d	L	L1	f	h	⊙				
A16R PWLNL 06	20	16	200	40	11	15	0,326	WNMG 0604	SW-SS-8	SW-KH-8B	2 Mm
A20R PWLNL 06	25	20	200	40	13	18	0,471				
A32T PWLNL 08	40	32	300	60	22	30	1,764				

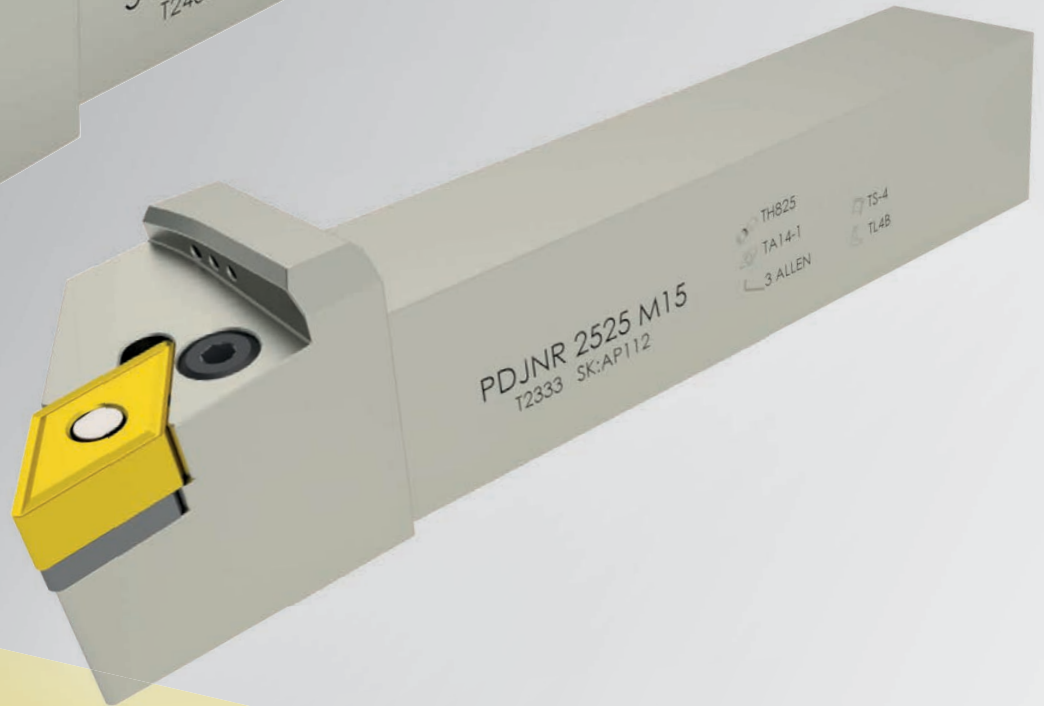
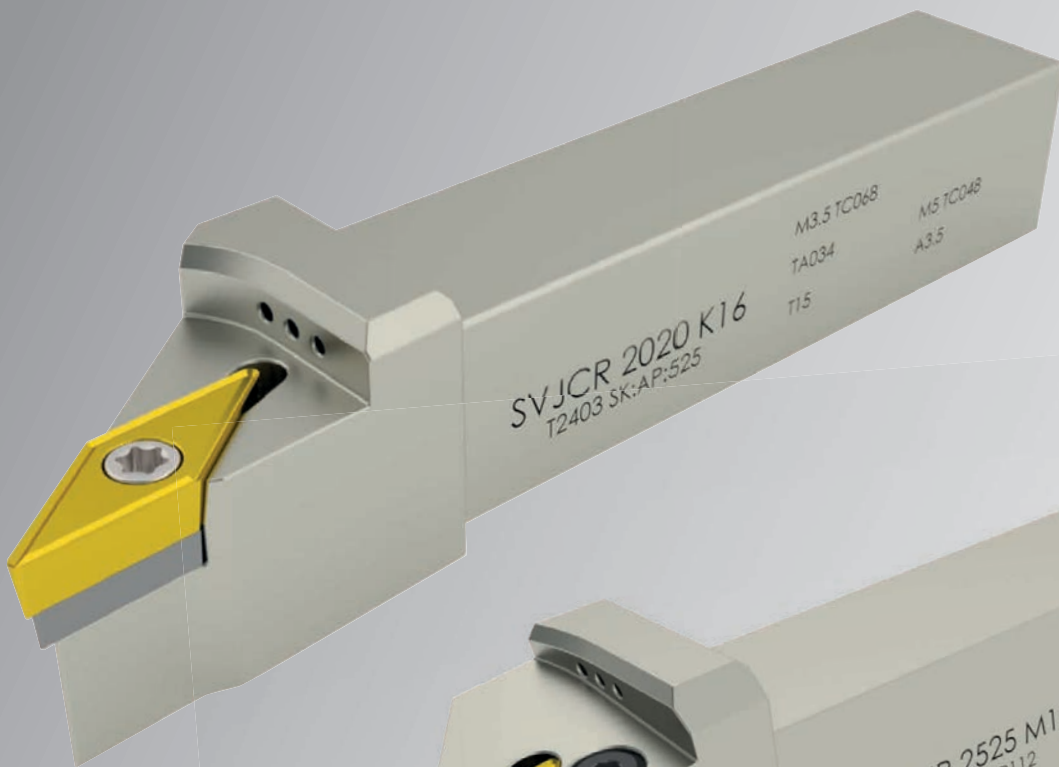

## **VHM SCHWARZ Präzisionswerkzeuge GmbH**

Lilienthalstr.3

70825 Korntal-Münchingen, Germany

Tel.: + 49 (0) 711 /51 87 88 10

Fax: + 49 (0) 711 /51 87 88 06

[www.vhm-schwarz.com](http://www.vhm-schwarz.com)

[info@vhm-schwarz.com](mailto:info@vhm-schwarz.com)